

ERROR MESSAGES

Error Message	Meaning
-SB-	Sensor connection is broken.
-Uf-	Process value is below the sensor scale.
-Of-	Process value is above the sensor scale.
nn	Process value is too high that it cannot be displayed.
-VV-	Process value is too low that it cannot be displayed.

SAFETY PRECAUTIONS

- Before using the device, please read the warnings below and this guide carefully.
- The accidents and damages resulting from not following the warnings included in this guide are under user's responsibility.
- Take the necessary precautions in order to prevent accidents and damages that may result in case the device gets faulty.
- Do not use this device in environments where flammable or explosive gases exist.
- do not allow metal fragments or lead wire scraps or liquid matters to fall inside this device.
- Do not touch the terminals while the device is energized (power on)
- Device will be out of guarantee when it gets faulty resulted from misusages.
- Do not power up the device before the connections related with the device are performed in accordance with connection diagram.

PRODUCT CODE

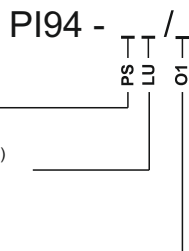

Supply Voltage : (PS)
0 = 100-240Vac (Universal)
1 = 24Vac/dc

Communication Unit Output Module : (LU)
0 = N/A
3 = RS485 Communication Unit

Analog Output Module : (O1)
0 = N/A
1 = 0/4-20mA Current Output
2 = 0/2-10V Voltage Output

Technical Service : ORDEL Ltd. Şti. Uzuncağı Cad. 1252. Sok. No:12 OSTİM/ANKARA
Tel:+90 312 385 70 96 (PBX) Fax: +90 312 385 70 78

DRAWINGS

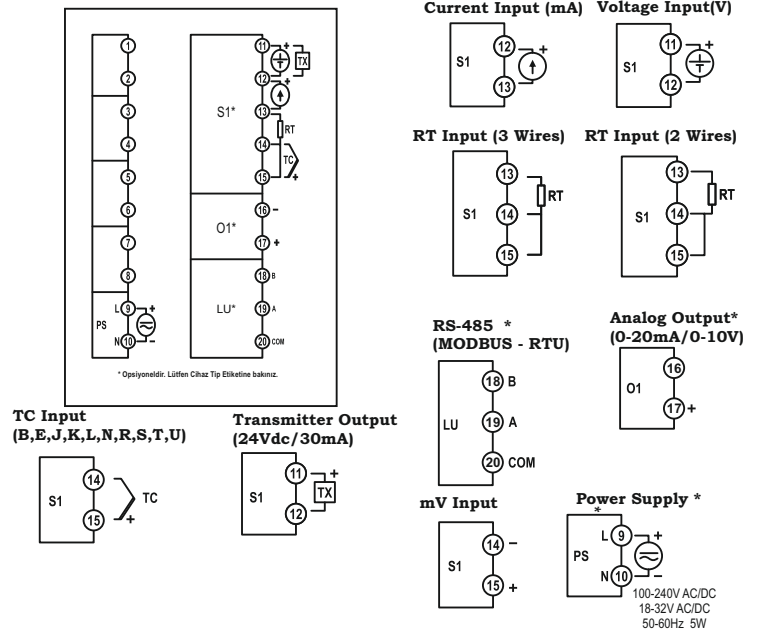

TECHNICAL SPECIFICATIONS

Besleme Gerilimi	100-240Vac/dc: +%10 -%15	24Vac/dc: +%10 -%20
Power	3W,5VA	
Universal Analog Input (S1)	Termocouple (B,E,J,K,L,N,R,S,T,U), Resistance Thermometer (Pt100), 2 Wire Transmitter, Current(0/4-20mA), Voltage (0-50mV, 0/2-10V)	
Transmitter Voltage	24Vdc (I _{sc} = 30mA)	
Analog Input Impedance	Termocouple: 10MΩ, Current: 10Ω, Voltage: 1MΩ	
Analog Output (O1)	Current: 0/4-20mA, 20-4/0mA (R _L ≤ 500Ω) Voltage: 0/2-10V, 10-2/0V (R _L ≥ 1MΩ)	
Memory	100 yıl, 100.000 renewals	
Doğruluk	+/- %0,2	
Sampling Time	100ms	
Environment Temperature	Operation: -10...+55C, Storage: -20...+65C	
Protection	IP20	
Dimensions	Width: 96 mm, Height: 48 mm, Depth: 110 mm	
Panel Cut-Out Dimensions	92+/-0,5 mm x45+/-0,5 mm	
Weight	320 gr	

SENSOR TYPES



Sensor Type	Standart	Temperature	
		(°C)	(°F)
Type B Termokupl	IEC584-1	60, 1820	140, 3308
Type E Termokupl	IEC584-1	-200, 840	-328, 1544
Type J Termokupl	IEC584-1	-200, 1120	-328, 1562
Type K Termokupl	IEC584-1	-200, 1360	-328, 2480
Type L Termokupl	DIN43710	-200, 900	-328, 1652
Type N Termokupl	IEC584-1	-200, 1300	-328, 2372
Type R Termokupl	IEC584-1	-40, 1760	104, 3200
Type S Termokupl	IEC584-1	-40, 1760	104, 3200
Type T Termokupl	IEC584-1	-200, 400	-328, 752
Type U Termokupl	DIN43710	-200, 600	-328, 1112
Pt100 Rezistans Termometre	IEC751	-200, 840	-328, 1544

COMMUNICATION ADDRESSES



Adress	Description	Unit	Mul.	Setting
0	Decimal Point (DP)			No
1	Process Value	EU	10^DP	No
Bit Type Parameters Adress				
Adress	Setting	Description (1 / 0)		
0	No	Process value is below the sensor scale (Yes / No)		
1	No	Process value is above the sensor scale (Yes / No)		
2	No	Sensor connection is broken error. (Var / Yok)		
3	No	Process Measurement Error (Yes / No)		

CONFIGURATION

238 Proses-Ekrani

  (Press these keys simultaneously for 2 seconds)



Entering Configuration Page Security Code

Enter security code with "" and "" keys.
(Default factory setting for the security code is









:

Configuration Parameters:
Upper display shows parameter name, lower display shows setting option.
To change the setting option, "" and "" keys are used.

CONFIGURATION PAGE PARAMETERS

Par. 01  OFF
In order to restore the settings to the factory default, this parameter should be set to "OFF" and "" key should be pressed for two
Setting Preferences: OFF, ON

Par. 02  1
It determines the decimal level (number of digits after dot) of all parameters which have a unit of "EU".
Setting Range : 0 - 3

Warning: When this parameter has been changed, all parameters which have a unit of "EU" should be set again.

Note: "EU", which is determined by "HU" parameter is a temperature unit for thermocouple or resistance thermometer measurements. Otherwise, it is an engineering unit that









Par. 03  1E
 1E-1
"S1" determines the sensor type which is connected to the universal sensor input. This sensor is used to measure the process
Setting Preferences: Table-1

Table-1	No	Sensor Type
1E-b	0	Type-B Thermocouple (Pt%18Rh-Pt)
1E-E	1	Type-E Thermocouple (Cr-Const)
1E-J	2	Type-J Thermocouple (Fe-Const)
1E-K	3	Type-K Thermocouple (NiCr-Ni)
1E-L	4	Type-L Thermocouple (Fe-Const)
1E-n	5	Type-N Thermocouple (Nicrosil-Nisil)
1E-r	6	Type-R Thermocouple (Pt%13Rh-Pt)
1E-s	7	Type-S Thermocouple (Pt%10Rh-Pt)
1E-t	8	Type-T Thermocouple (Cu-Const)
1E-U	9	Type-U Thermocouple (Cu-Const)
rE	10	Pt-100 Resistance Thermometer
0-50	11	0-50mV
0-20	12	0-20mA
4-20	13	4-20mA
0-10	14	0-10V
2-10	15	2-10V

Par. 04  1E
It determines the lower scale value of "S1" universal sensor input module.
Setting Range : 1999 - 9999 Unit : EU

Par. 05  1E
 800
It determines the higher scale value of "S1" universal sensor input module.
Setting Range : 1999 - 9999 Unit : EU

Par. 06  1E
 H
It determines the value which scala will be set to when the universal sensor input connection is broken.
Setting Preferences : L (Low value) , H (High value)

Par. 07  HU
It determines the temperature unit for the measurements of thermocouples or resistance thermometers.
Setting Preferences : °C (°C), °F (°F)

Par. 08  1E
While measuring with thermocouples or resistance thermometers, in order to correct measurement errors, it is
Setting Range : 1000 - 1000 Unit : EU

Par. 09  F5
It determines the time constant of digital filter that is applied to analog inputs. If this value is increased, reading stability increases but





Par. 10  0 1E
It determines the type of "O1" analog output module.
Setting Preferences : Table-5

Table-5	No	Analog Output Type
0-20	0	0-20mA
20-0	1	20-0mA
4-20	2	4-20mA
20-4	3	20-4mA
0-10	4	0-10V
10-0	5	10-0V
2-10	6	2-10V
10-2	7	10-2V



Note: In order to be able to use the first four preferences, this module should be identified as being "0/4-20mA" in product code. As for the last four preferences, "0/2-10V" should be

Par. 11  0 1E
It determines the lower value of output scale when "O1" analog output module is used as a transmitter.
Setting Range : 1999 - 9999 Unit : EU

Par. 12  0 1E
 800
It determines the upper value of output scale when "O1" analog output module is used as a transmitter.
Setting Range : 1999 - 9999 Unit : EU

Par. 13  Add
It determines the serial communication address. All addresses should be unique that are connected to a serial
Setting Range : OFF (Closed) , 1 - 255 Birim : EU

Par. 14  bRU
It determines the serial connection speed.
Setting Preferences : 9.6 , 19.2 , 38.4 Birim :

Par. 15  PrE
 EU
It determines the parity type in serial communication.
Setting Preferences : none (None) , odd (Odd) ,

Par. 16  5 C.2
It determines the security code for Configuration page.
Setting Range : 1999 - 9999