

FC991

Flow Controllers USERS' GUIDE

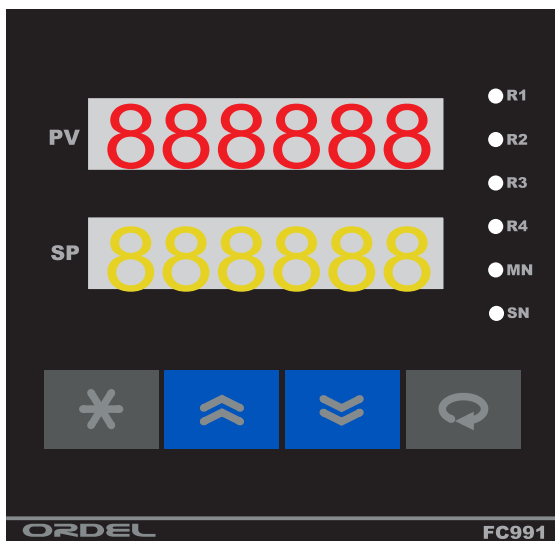

ORDEL



- Before using the device, please read the warnings below and this guide carefully. The accidents or damages resulting from not following the warnings included in this guide are under user's responsibility.
- This device is intended to be used by qualified personnel in industrial environments, do not use in houselike environments.
- Do not use the device at places where corrosive, flammable and explosive gases exist. Contact points may create electrical discharge and this may cause explosion or fire.
- Do not allow metal fragments or lead wire scraps or liquid matters to fall inside this device. Otherwise fire or electrical shock may happen.
- Take the necessary precautions in order to prevent accidents and damages that may result in case the device gets faulty.
- There is no fuse or switch that brings the device in power down state, these should be added to the system by the user.
- Sensor and signalling cables should not be routed close to the power cables or inductive load cables.
- Do not power up the device before the connections related with the device are performed in accordance with connection diagram.
- Do not power up the device before the connections related with the device are performed in accordance with the connection diagram. While the device is powered, do not touch on the terminals.
- Configuration settings at factory out should be changed according to the user's preferences. The accidents and damages resulting from incorrect configuration settings are under users' responsibility.
- Never disassemble, repair and modify the device. These should be carried out by authorized service.

SECTION	Sayfa No:
Safety Precautions	2
Contents	3
Description of the Device	4
Preparations	5
Connection Diagram	6
Connection Samples	7
Product Code	8
Technical Specifications	9
Display and Key Functions	10
Display and Key Functions	11
Configuration	12
Configuration Pages Input	13
Configuration <u>Page Parameters</u>	14
Operator Page	21
Operator Page <u>Parameters</u>	22
Using Logic Inputs	23
Serial Communication	24
Notes	26

FC991 model devices, pulse, current and voltage inputs can be programmed as a current or voltage input is set to a flow measurement devices. Device input is a linear function. Device set-point and 4 digital output will oversee four separate properties. instantaneous flow values are set, the value of the collection and can be assigned to the batch. Analog Output module and the instantaneous flow, total and batch information to transfer is used. Measurement data to a central system via RS485 MODBUS RTU protocol over the line device connected, transferred. Communication line 128.

Compliance with international standards in the design phase, these devices are based on

2 Adet 6 Digit Numerik Gösterge**11 Digit Toplam ve Bach Toplam Toplayıcı****1 Item Transmitter Supply Output (24Vdc)****Sensor Inputs (mA, mV , V, Pulse (NPN and PNP) , mechanical contact or Proximity Switch)****2 Item Digital Input 15V (to Reset Total and Total value of Bach)****1 Item RS485 Communication Unit****2 Item Analog Output (0/4-20mA, 0/2-10V)****4 Item Relay or Logic Output (24V)****100-240Vac Universal or 24Vac/dc Supply****Isolation between input/output modules****Retransmission (For process and set value)****7 Different Relay Functions****On-Off Control****100ms Sampling and Control Cycle****Standard MODBUS RTU Communication Protocol**

- ◆ Making use of this user's guide before using the appliance and carry out the following sequence of operations.
- ◆ FC991 Model devices so completely modular devices before using the device by looking at the supply voltage and the input and output modules in the product code, be sure to check whether it is appropriate.
- ◆ Give other device Before connecting the supply voltage and the configuration page by entering only the most appropriate configuration of your system, please.
- ◆ After the device has been configured in accordance with the operator on a set of selected alarm relays and hysteresis values .
- ◆ Please power off the device and other connections according to the wiring diagram.
- ◆ Set the Control to be ready to operate the system and provide energy to the system with the device again.
- ◆ During normal use, be sure to check all functions of the device.
- ◆ Finally, interventions in order to prevent unauthorized persons entering the configuration page to set security-related parameters, and return to the Process-Screen.

This manual was prepared according to the procedure above. How these processes are given in detail in the relevant sections.

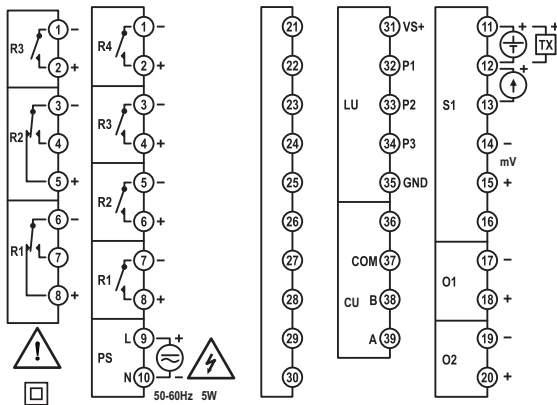

(*) Optional. Refer to type label.

Diagram-1

Module	Explanation
S1	Universal sensor input module (This sensor that is used to measure process value should be connected to the terminal which is identified with suitable symbols in this module).
LU	Pulse measurement or logic input module is used to reset the total value and the sum of the entries back.
O1,O2	Analog Output modules (content of this module product code and the function of the configuration page "0 !,F" is determined by parameter).
R1,R2,R3,R4	Relay Output Modules (product code and the content of this module, the functions of the configuration page "r !,F, r 2,F" is determined by the parameters).
PS	Supply voltage input (supply voltage is determined by the product code).

4 Relay NO Contact Tips:

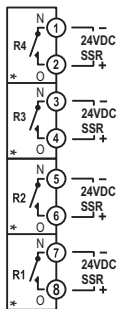

Connecting the Logic inputs:

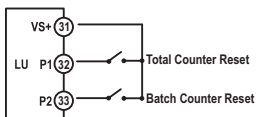

mv Voltage Input:

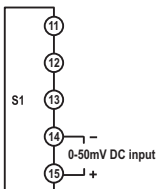

V Voltage Input:

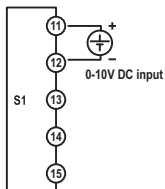

2 Relay NO / NC Contact Inserts:

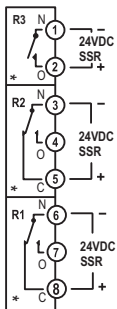

O1-O2 Analog Output :

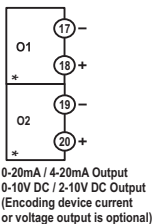

Current Input:

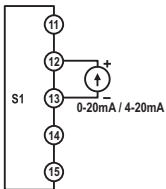

2-Wire Transmitter Link:

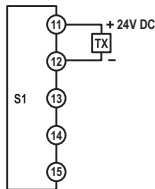

NPN Pulse Input Connection Diagram :

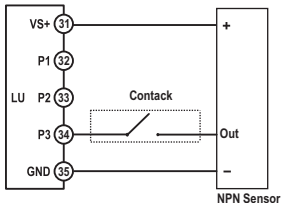

PNP Pulse Input Connection Diagram :

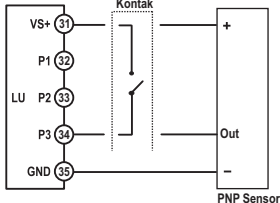

Supply Inserts :



100/240V DC/AC
18/32V DC/AC
50/60HZ

RS485 Communication Inserts:

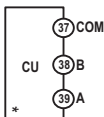

PNP Sensor
Installing Pin



NPN Sensor
Installing Pin

Note: The modules are marked with an asterisk for optional. For information, see the module coding device.

FC991 - T T / T T / T T T T

RS CU O1 O2 R1 R2 R3 R4

Supply Voltage

0 = 100-240Vac (Üniversal)

1 = 24Vac/dc

Communication Modüle

0 = Yok

3 = RS485 İletişim Birimi

O1,O2 Analog Output Modüle

0 = Yok

1 = 0/4-20mA Akım Çıkış

2 = 0/2-10V Gerilim Çıkış

R1,R2 Output Module

0 = Yok

1 = NO Kontak

2 = 24V Lojik Çıkış (SSR Sürmek İçin)

3 = NO/NC Kontak

R2,R3 Output Module

0 = Yok

1 = NO Kontak

2 = 24V Lojik Çıkış (SSR Sürmek İçin)

Relay output modules can be identified as contact of logic output in product code. But in this user's guide relay term is used to represent both.

Supply Voltage (PS)	100-240V AC/DC - 18-32V AC/DC (+%10 -%15) 50-60HZ		
Power Consumption	5W,8VA		
Sensor Input	Two Wire Transmitter : 4-20mA		
	Current : 0-20mA / 4-20mA		
	Voltage : 0-50mV , 0-10V		
	Puls (NPN, PNP)		Reading up to 8000 Hz
	Mechanic Contact, Proximity Switch Contact		
Transmitter Supply (TX)	24Vdc (I _{sc} = 30mA)		
Analog Input Impedance	Thermocouple, mV : 10MΩ		
	Current : 10Ω		
	Voltage : 1MΩ		
Analog Outputs (O1,O2)	Current : 0/4-20mA (RL ≤	Voltage : 0/2-10V (RL ≥ 1MΩ)	
Relay Outputs (R1,R2,R3,R4)	Contact : 250Vac, 5A	Logic Output : 24Vdc, 20mA	
Contact Life	No-load : 10.000.000 switching		
	250V, 5A Resistive Load: 100,000 switching		
Memory	100 years, 100.000 renewals		
Accuracy	+/- %0.2		
Sampling Time	100ms		
Environment Temperature	Operation : -10...+55C		Stroke : -20...+65C
Protective Class	Front Panel : IP54		Trunk : IP20
Dimensions	Width : 96mm	Height : 96mm	Dept : 110mm
Panel Cut Dimensions	96+/-0,5 mm x 96+/-0,5 mm		
Weight	430gr		

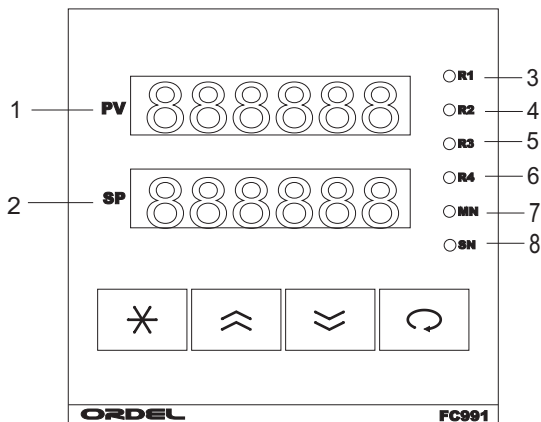

SCREEN PROCESS :

When power is on, the display program version is displayed for 2 seconds, then "1" on the display the measured flow value or the error message, "2", the total value will appear on the display. Process-Screen This screen is called. During normal operation, this screen is used.

1	1.FAULT	Process-Display instantaneous flow value or error messages, and other displays show the parameter name.
2	2. FAULT	Process-Screen button is pressed, batch up the total and the total value of this indicator, the other screen shows the value of the parameter.
3	R1 LED	"R1" relay is energized.
4	R2 LED	"R2" relay is energized.
5	R3 LED	"R3" relay is energized.
6	R4 LED	"R4" relay is energized.
7	MN LED	This model is not used.
8	SN LED	This model is not used.





SYMBOLISATION OF ALPHABETICAL CHARACTERS

A	B	C	D	E	F	G	H	I	J	K	L	M
A	b	C	d	E	F	G	H	I	J	K	L	M
N	O	P	Q	R	S	T	U	V	W	X	Y	Z
n	o	P	q	r	s	t	U	v	w	x	y	z

ERROR MESSAGES

<i>Err. 1</i>	Sensor connection is broken at "S1" input.
----	Process value is above the display scale.
----	Process value is below the display scale.

KEY FUNCTIONS

	While in Process-Screen, if it is pressed shortly, locked relays are resetted. Pressing for 5 seconds will change the operating mode. While in other screens, it is used to revert to the first page. Pressing for 2 seconds will activate the Process-Screen.
	It is used to change the parameter option or parameter value.
	It is used to change the parameter option or parameter value.
	In any page, pressing for a while activates the next parameter. While in Process-Screen, pressing for 5 seconds will start the Auto-Tune operation. For submit operations, it must be pressed for 2 seconds.

FC991 Series devices are designed for flow measurement devices. For this reason, 'pulse, mV, mA, V, input modules are available to suit all kinds of devices operating condition. Each of these devices can be used to control a separate output. Therefore, before using FC991 device, input / output types and functions, the control must be set to the most appropriate types and usage.

FC991 series devices, depending on ordering code with four analog input, analog output and two relay outputs, RS485 communication module can be found. These types of modules, functions and scales are determined by the parameters configuration page.

In addition, the operation of the control type and control algorithm that determines the basic parameters and settings that are required for the configuration page.

Before connecting a device not configured your system configured according to the following instructions and be sure to give only the supply voltage.

Entering the configuration page and setting up parameters:

- ◆ In order to enter the configuration page, press “[*]” and “[<]” keys simultaneously and continuously until “C.2” message appears in “PV” display when device is energized.
- ◆ Set the security code by pressing “[>]” and “[<]” keys by setting the value of “SP” display to configuration page security code when “C.2” message still appears in PV display (Default factory setting of this security code is “0”).
- ◆ If the security code is not valid when you have pressed “[<]” key, Process-Screen is to be reverted, otherwise first parameter of the configuration page is accessed.
- ◆ In parameter display, parameter name is displayed in “PV” display, preferences of the parameter setting is displayed in “SP” display.
- ◆ Now, you can access other configuration parameters in order by pressing “[<]” key .
- ◆ In order to change preferences of parameter setting, use “[>]” and “[<]” keys, in order to step to the next parameter use “[<]” key. A short time press of “[*]” key makes you to access the start of page, a long time press makes you to return the Process-Screen.
- ◆ Below, you can find a graphical representation of these instructions in **Figure-3**.
- ◆ **Note:** In order to step through in configuration page with parameter numbers displayed, press “[*]” and “[<]” keys simultaneously.

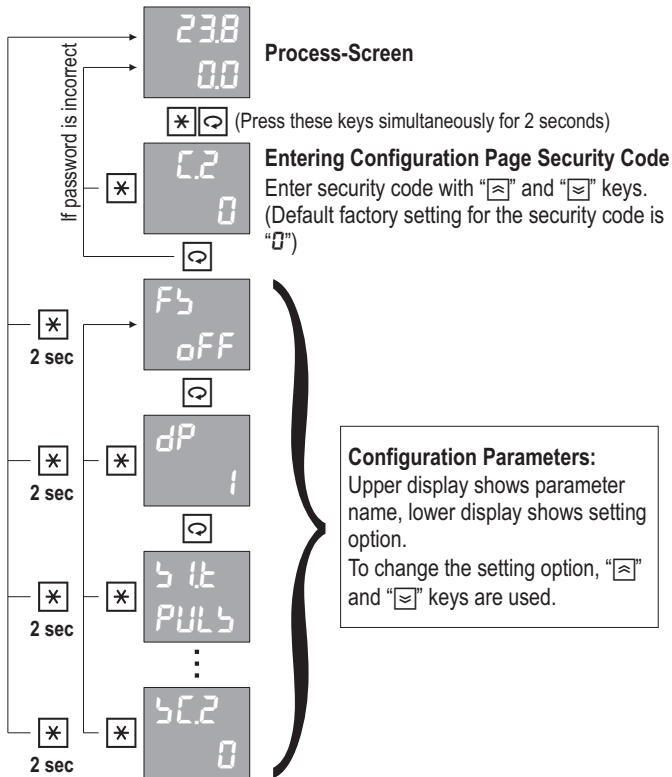





Figure-3

Detailed information about configuration page parameters can be found in the next section.

Par. 01 —  In order to restore the settings to the factory default, this parameter should be set to "on" and "☐" key should be pressed for two seconds.
Setting Preferences: OFF, on

Par. 02 —  It determines the decimal level (number of digits after dot) of all parameters which have a unit of "EU".
Setting Range : 0 - 3

Par. 03 —  "S1" determines the sensor type which is connected to the universal sensor input. This sensor is used to measure the process value.
Setting Preferences: Table-1

Tablo-1	No	Sensor Type
PULS	0	PULS
0-50	1	0-50mV
0-20	2	0-20mA
4-20	3	4-20mA
0-10	4	0-10V

Par. 04 —  It determines the lower scale value of "S1" universal sensor input module.
Setting Range : 0 - S1HL *Unit : EU*

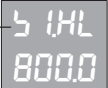
Par. 05 —  It determines the higher scale value of "S1" universal sensor input module.
Setting Range : S1LL - 32000 *Unit : EU*

Par. 06 —  It determines the value which scala will be set to when the universal sensor input connection is broken.
Setting Preferences : L (Low value) , H (High value)

Par. 07 —  It determines the time constant of digital filter that is applied to analog inputs. If this value is increased, reading stability increases but reading speed decreases.
Setting Range : 0.1 - 10.0 *Unit : sec*

Par. 08		<p>Parameter that determines the pace of the adder. Minutes or hours can be adjusted. The choices made by the instantaneous flow volume / minute or volume / time is controlled by the advancement of the collector.</p> <p><i>Setting Preferences: 555 (second) , 0.0 (minute) , Hour (</i></p>
Par. 09		<p>Parameter that determines the minimum value for the progress of the collector current of the stream. 0 with SPLL between parameter setting. Instantaneous flow is smaller than the value entered in this parameter does not go to the collector.</p> <p><i>Setting Preferences : 0,0 - 5 SPLL between</i></p>
Par. 10		<p>If given in the form of pulse stream information to the device, the device calculates the value of the time between successive pulses the two. TFR time interval between two consecutive input pulses exceeds the current value is reset. TFR for applications with a low incidence of stroke ayarlanmalıdır. Bu a long enough period of time the minimum value that can be measured instantaneous flow effects.</p> <p><i>Unit is in seconds. Setting range 1...250 sec</i></p>
Par. 11		<p>If given a mechanical contact with the flow stream to the device, the ignition will result in shifts in order to prevent erroneous counting process determines the length of the delay impact. Input pulses are received semiconductor sensors to "0" must be set. This parameter is limited to a non-zero frequency of the input pulses. For example, 5 is set to 5 milliseconds after changing the input pulse position is evaluated. Therefore, greater than the maximum pulse frequency 100HZ. 100 Hz pulses are not counted.</p> <p><i>Unit is in milliseconds. Setting range 0...100 msec</i></p>
Par. 12		<p>Multiplier value. $3600 \times$ Incoming pulses information $\times FrP / PPU$ partitioned. The results are displayed.</p> <p><i>Setting range : 1 -18</i></p>
Par. 13		<p>The divisor value. $3600 \times$ Incoming pulses information $\times FrP / PPU$ partitioned. The results are displayed.</p> <p><i>Setting range : 0 - 30000</i></p>

Par. 14



It determines the function of "O1" analog output module.

Setting Range : 0 - 100

Par. 15



It determines the function of "O1" analog output module.

Setting Preferences : Table-4

Tablo-4	No	Analog Output Function
oFF	0	N/A
FLoW	1	Real Time Flow Measurement Transmission (Transmitter)
tPFL	2	Total Measured value transmission (Transmitter)
tbfL	3	Measuring Value of Batch Transmission (Transmitter)

Par. 16



It determines the type of "O1" analog output module.

Setting Preferences : Table-5

Table-5	No	Analog Output Type
0-20	0	0-20mA
20-0	1	20-0mA
4-20	2	4-20mA
20-4	3	20-4mA
0-10	4	0-10V
10-0	5	10-0V
2-10	6	2-10V
10-2	7	10-2V

Note: In order to be able to use the first four preferences, this module should be identified as being "0/4-20mA" in product code. As for the last four preferences, "0/2-10V" should be used as identifying code.

Par. 17



It determines the lower value of output scale when "O1" analog output module is used as a transmitter.

Setting Range: -199.99 - 32000

Unit : EU

Par. 18



It determines the upper value of output scale when "O1" analog output module is used as a transmitter.

Setting Range: -199.99 - 32000

Unit : EU

Par. 19



It determines the function of "O2" analog output module.

Setting Preferences : Table-4

Tablo-4	No	Analog Output Function
oFF	0	N/A
FLoW	1	Real Time Flow Measurement Transmission (Transmitter)
tPFL	2	Total Measured value transmission (Transmitter)
tbfL	3	Measuring Value of Batch Transmission (Transmitter)

Par. 20

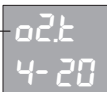

It determines the type of "O1" analog output module.

Setting Preferences : Table-5

Table-5	No	Analog Output Type
0- 20	0	0-20mA
20- 0	1	20-0mA
4- 20	2	4-20mA
20- 4	3	20-4mA
0- 10	4	0-10V
10- 0	5	10-0V
2- 10	6	2-10V
10- 2	7	10-2V

Note: In order to be able to use the first four preferences, this module should be identified as being "0/4-20mA" in product code. As for the last four preferences, "0/2-10V" should be used as identifying code.

Par. 21

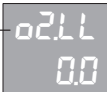

It determines the lower value of output scale when "O1" analog output module is used as a transmitter.

Setting Range: -199.99 - 32000

Unit : EU









Par. 22		It determines the upper value of output scale when "O1" analog output module is used as a transmitter.	
		Setting Range: -199.99 - 32000	Unit : EU



Par. 23		It determines the function of "R1" relay output module.	
		Setting Preferences : Table-6	

Tablo-6	No	Relay Function	
oFF	0	N/A	
PFL	1	Upper Limit Control	ALARMS
nFL	2	Lower Limit Control	
PtF	3	Upper Limit Alarm	
ntF	4	Lower Limit Alarm	
Pbt	5	Upper Limit Alarm	
rbt	6	Lower Limit Alarm	
PUL	7	Pulse Output	

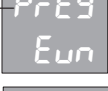
Note: Hatched areas are hysteresis areas and hysteresis of each relay is determined with its "Hh.n" parameter. ("N" represents the relay number)

"1" in table means that related relay is powered on and "0" means powered off.

Par. 24		It determines the function of "R2" relay output module.
		<i>Setting Preferences</i> : Table-6
Par. 25		It determines the function of "R3" relay output module.
		<i>Setting Preferences</i> : Table-6
Par. 26		It determines the function of "R4" relay output module.
		<i>Setting Preferences</i> : Table-6
Par. 27		"r tF, r2F" parameters another (PUL) when selected determines whether a pulse on how many liters.
		<i>Setting Preferences</i> : 0 - 9999
Par. 28		"r tF, r2F" parameters another (PUL) when selected determines whether relays a pulse time.
		<i>Setting Preferences</i> : 0 - 100
Par. 29		It determines the serial communication address. All addresses should be unique that are connected to a serial communication line.
		<i>Setting Range</i> : off(Closed) , 1 - 255 <i>Unit</i> : EU
Par. 30		It determines the serial connection speed.
		<i>Setting Preferences</i> : 9.6 , 19.2 , 38.4 <i>Unit</i> : Kbps
Par. 31		It determines the parity type in serial communication.
		<i>Setting Preferences</i> : nonE(None) , odd(Odd) , Eun(Even)
Par. 32		Parameter for the buttons on the front panel to reset the concentrator. The home screen, press  and then pressed simultaneously in order before * resets the collector.
		<i>Setting Preferences</i> : EnbL(Open) , dLbL(Close)

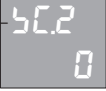
Par. 31		<p>Keys on the front panel to reset the batch parameter for the collector. At the same time in order before the home screen, press * then $\hat{\wedge}$ is pressed, batch totalizer is reset.</p>
		<p><i>Setting Preferences:</i> <i>EnbL</i> (Open) , <i>d̄bL</i> (Close)</p>
Par. 32		<p>Parameter determines the logic to reset the adder inputs. 9 in connection with Refer to the wiring diagram on the page logic.</p>
		<p><i>Setting Preferences:</i> <i>EnbL</i> (Open) , <i>d̄bL</i> (Close)</p>
Par. 33		<p>Batch adder logic inputs determine the parameter resets. 9 in connection with Refer to the wiring diagram on the page logic.</p>
		<p><i>Setting Preferences:</i> <i>EnbL</i> (Open) , <i>d̄bL</i> (Close)</p>
Par. 34		<p>It determines the security code for Configuration page.</p>
		<p><i>Setting Range :</i> <i>1999 - 9999</i></p>

The operator on the values of the set of relays (set1 , set2 , set3 , set4), and this sets the values of the hysteresis (hys1, hys2, hys3, hys4) are parameters. In order to achieve these parameters at any time while the process-Screen, "↻", these parameters can be accessed by pressing the "*" again by pressing the Process-Screen will be restored.

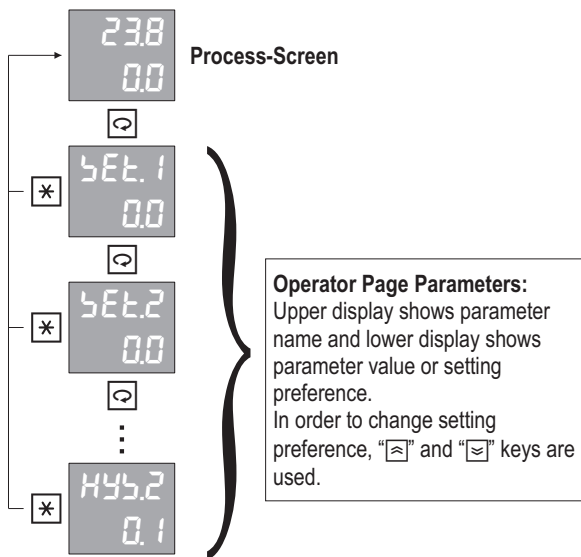

Detailed information about operator page parameters can be found in the next section.

<p>SEt.1 0.0</p>	<p>It determines the set value of "R1" module. In order to make this parameter visible, "r 1F" parameter should be selected as ALARM.</p>	<p>Setting Range : [5PLL] - [5PHL]</p>	<p>Unit : EU</p>
<p>SEt.2 0.0</p>	<p>It determines the set value of "R2" module. In order to make this parameter visible, "r 2F" parameter should be selected as ALARM.</p>	<p>Setting Range : [5PLL] - [5PHL]</p>	<p>Unit : EU</p>
<p>SEt.3 0.0</p>	<p>It determines the set value of "R3" module. In order to make this parameter visible, "r 3F" parameter should be selected as ALARM.</p>	<p>Setting Range : [5PLL] - [5PHL]</p>	<p>Unit : EU</p>
<p>SEt.4 0.0</p>	<p>It determines the set value of "R4" module. In order to make this parameter visible, "r 4F" parameter should be selected as ALARM.</p>	<p>Setting Range : [5PLL] - [5PHL]</p>	<p>Unit : EU</p>
<p>HYS 0.1</p>	<p>It determines the control hysteresis value. In order to make this parameter visible, one of the proportional band should be selected as being "OFF".</p>	<p>Setting Range : 0.1 - 100.0</p>	<p>Unit : EU</p>
<p>HYS.1 0.1</p>	<p>It determines the hysteresis value of "R1" module. In order to make this parameter visible, "r 1F" parameter should be selected as being ALARM.</p>	<p>Setting Range : LEL(Locked) , 0.1 - 100.0</p>	<p>Unit : EU</p>
<p>HYS.2 0.1</p>	<p>It determines the hysteresis value of "R2" module. In order to make this parameter visible, "r 2F" parameter should be selected as being ALARM.</p>	<p>Setting Range : LEL(Locked) , 0.1 - 100.0</p>	<p>Unit : EU</p>
<p>HYS.3 0.1</p>	<p>It determines the hysteresis value of "R3" module. In order to make this parameter visible, "r 3F" parameter should be selected as being ALARM.</p>	<p>Setting Range : LEL(Locked) , 0.1 - 100.0</p>	<p>Unit : EU</p>
<p>HYS.4 0.1</p>	<p>It determines the hysteresis value of "R4" module. In order to make this parameter visible, "r 4F" parameter should be selected as being ALARM.</p>	<p>Setting Range : LEL(Locked) , 0.1 - 100.0</p>	<p>Unit : EU</p>

The use of logic input module :

These devices, "LU" logic input is logic input module 3. This wiring diagram for inputs, respectively, P1, P2, P3, and VS + end appears to be connected to these inputs work. To reset the total value of P1, P2 to reset the sum of the batch, is used for the measurement of pulse P3.

LOGIC INPUT RESET :

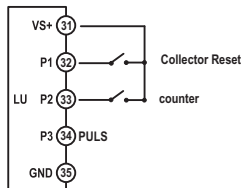

Pulse Input Connection Diagram:

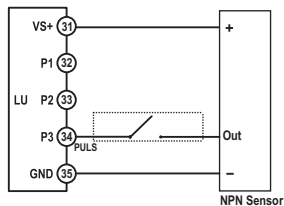
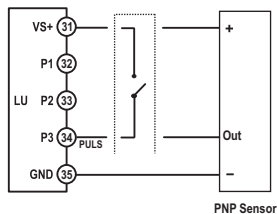

Model FC991 devices are designed to be communicated in slave mode with MODBUS RTU protocol. All parameters and registers can be accessed with this communication type. Parameters can be read or can be set to a value.

Serial communication is established with Half-Duplex RS485 line. 32 devices can be connected to one RS485 line.

The cable which is used in communication line should be a data cable that is compatible with Half-Duplex RS485 communication and this cable should be connected parallel to all devices as a single line. Both cable ends should be terminated with a appropriate resistance. A communication line which is appropriate for 9600 Bps data transmission speed can be up to 1000m.

Each device on serial communication line should have an unique address between 1 and 255 but all devices in this line should have same speed and parity type. Communication address, speed and parity type of these devices are determined with "Addr, bAud ve PrtY" parameters which are in configuration page.

Below, you can find information about functions which are supported by MODBUS RTU, parameter addresses and others in tables.

Supported Standard MODBUS RTU Functions:

Function 01 = Read Coils

Function 03 = Read Holding Registers

Function 05 = Write Single Coil

Function 06 = Write Single Register

Function 16 = Write Multiple Registers

BIT Type Parameters (COILS)

Address	Explanation (1 / 0)	Set Perm.
0		
1	"R1" relay module (ON / OFF)	
2	"R2" relay module (ON / OFF)	
3	"R3" relay module (ON / OFF)	
4	"R4" relay module (ON / OFF)	
5	ERR1 Error (Yes / No)	No
6		
7		
8		

REGISTER Type Parameters (REGISTERS)

Adres	Explanation	Setting Range		Mul.	Unit	Set Perm.
0	Valid decimal point	0	3	1		No
1	Measured process value	-1999	9999	10 ^{DP}	EU	No
20-21	The total value (32 bit) 4 bayt					
22-23	Bach total value (32 bit) 4 bayt					

www.ordel.com.tr

Üretici ve Teknik Servis :

ORDEL Ltd. Şti. Uzayçağı Cad. 1252. Sok. No:12 OSTİM / ANKARA
Tel:+90 312 385 70 96 (PBX) Fax: +90 312 385 70 78

ORDEL